

SERIES 8 & 9 (3+0)

P/N: 8S603
P/N: 9S417

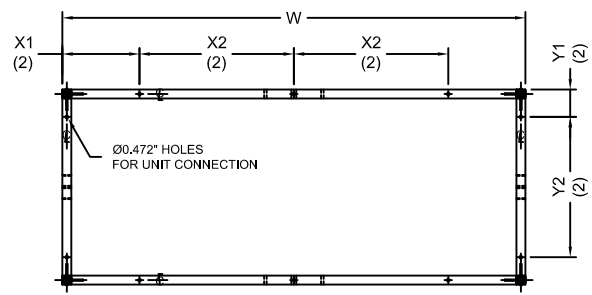

PLAN

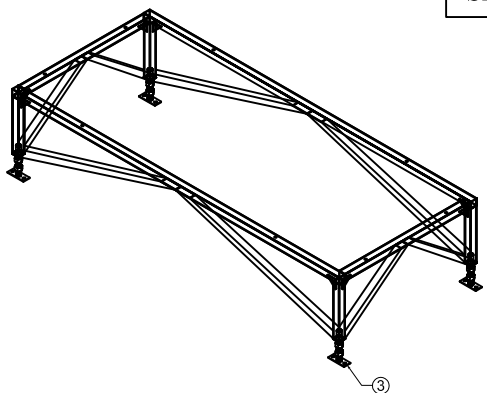
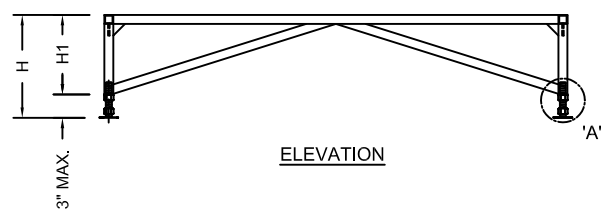

ELEVATION

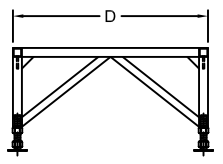

END VIEW

SERIES 9 (4+0)

P/N: 9S418

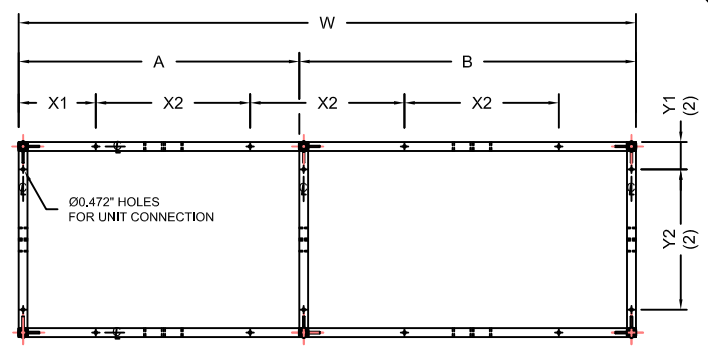
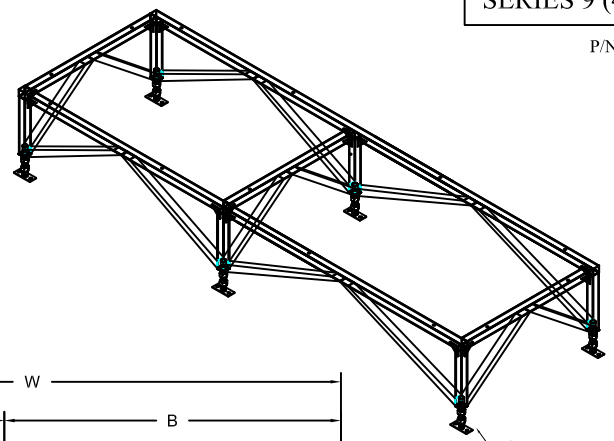

PLAN

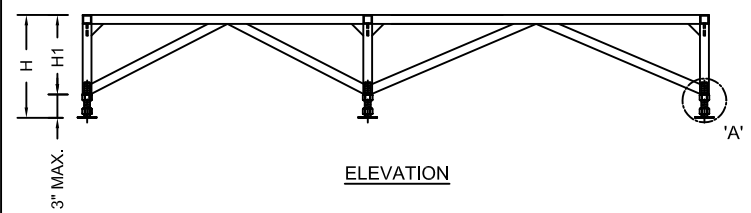

ELEVATION

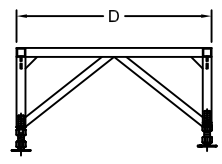

END VIEW

ITEM NO.	DESCRIPTION	W	D	H	H1	A	B	X1	X2	Y1	Y2
8S603	FLOOR STAND Series 8	51.968"	32.835"	H ±1.000"	H-3.000"	-	-	12.992"	25.985"	4.606"	23.622"
9S417	FLOOR STAND Series 9 (3+0)	77.953"	32.835"	H ±1.000"	H-3.000"	-	-	12.992"	25.985"	4.606"	23.622"
9S418	FLOOR STAND Series 9 (4+0)	103.936"	32.835"	H ±1.000"	H-3.000"	47.250"	56.686"	12.992"	25.985"	4.606"	23.622"

NOTE: H - TOTAL HEIGHT OF FLOOR STAND (ADJUSTABLE TO ±1.000")
H1 - HEIGHT OF FLOOR STAND w/o ADJUSTABLE PEDESTAL

MATERIAL: FRAME - 1.50" MILD STEEL SQUARE TUBE

FINISH: PAINTED - POWDERED COATED - BLACK

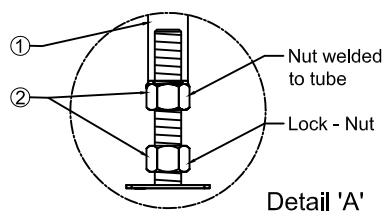

Detail 'A'

ITEM	MATERIAL & COMPONENT
①	1.500" Mild Steel Square Tube
②	3/4" Heavy Semi-finished Hex Nut (Coarse thread)
③	Adjustable Pedestal (P/N: 9C401)