

SERIES 9 (2+1) & (3+1) ["A" & "B" MODULE]

P/N: 9S401-01
P/N: 9S401-02
P/N: 9S401-03
P/N: 9S401-04

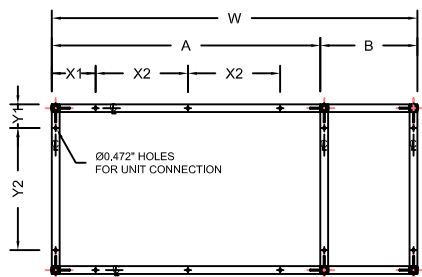

PLAN

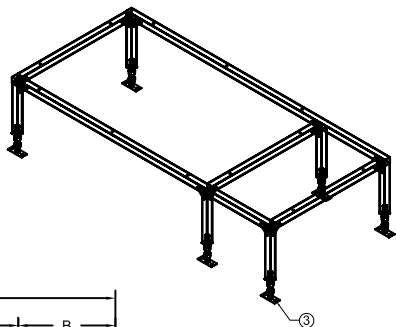
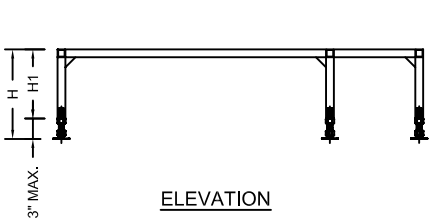

ELEVATION

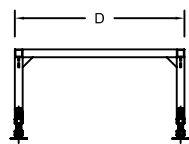

END VIEW

SERIES 9 (4+1) ["A" & "B" MODULE]

P/N: 9S403-01
P/N: 9S403-02

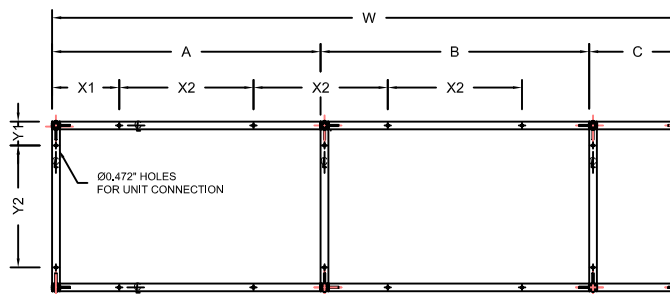
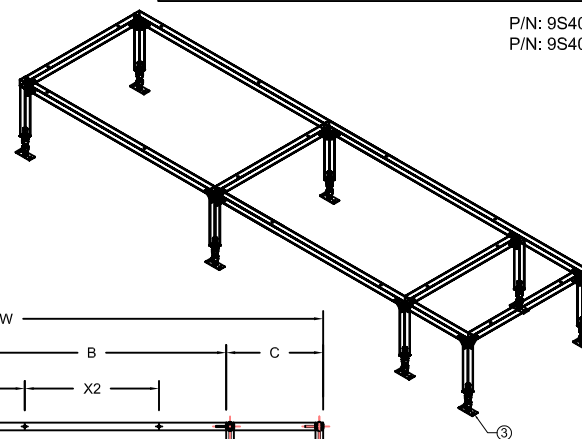

PLAN

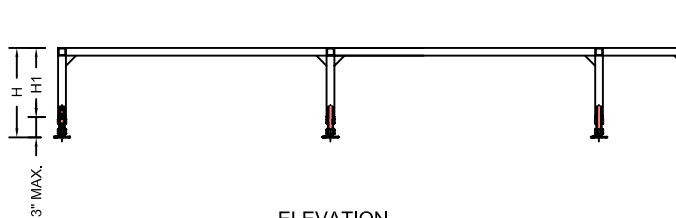

ELEVATION

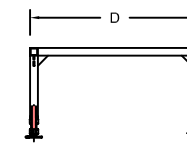

END VIEW

ITEM NO.	DESCRIPTION	W	D	H	H1	A	B	C	X1	X2	Y1	Y2
9S401-01	FLOOR STAND Series 9 (2+1) "A" Module	70.747"	32.835"	H ±1.000"	H-3.000"	51.968"	18.779"	-	12.992"	25.985"	4.606"	23.622"
9S401-02	FLOOR STAND Series 9 (2+1) "B" Module	79.921"	32.835"	H ±1.000"	H-3.000"	51.968"	27.953"	-	12.992"	25.985"	4.606"	23.622"
9S401-03	FLOOR STAND Series 9 (3+1) "A" Module	96.732"	32.835"	H ±1.000"	H-3.000"	77.953"	18.779"	-	12.992"	25.985"	4.606"	23.622"
9S401-04	FLOOR STAND Series 9 (3+1) "B" Module	105.906"	32.835"	H ±1.000"	H-3.000"	77.953"	27.953"	-	12.992"	25.985"	4.606"	23.622"
9S403-01	FLOOR STAND Series 9 (4+1) "A" Module	122.715"	32.835"	H ±1.000"	H-3.000"	47.250"	56.686"	18.779"	12.992"	25.985"	4.606"	23.622"
9S403-02	FLOOR STAND Series 9 (4+1) "B" Module	131.889"	32.835"	H ±1.000"	H-3.000"	47.250"	56.686"	27.953"	12.992"	25.985"	4.606"	23.622"

NOTE: H - TOTAL HEIGHT OF FLOOR STAND (ADJUSTABLE TO ±1.000")
H1 - HEIGHT OF FLOOR STAND w/o ADJUSTABLE PEDESTAL

MATERIAL: FRAME - 1.50" MILD STEEL SQUARE TUBE

FINISH: PAINTED - POWDERED COATED - BLACK

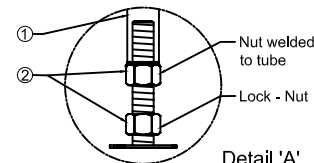

Detail 'A'

ITEM	MATERIAL & COMPONENT
①	1.500" Mild Steel Square Tube
②	3/4" Heavy Semi-finished Hex Nut (Coarse thread)
③	Adjustable Pedestal (P/N: 9C401)