

DATE PRINTED: 5/15/2015

REVISIONS			
REV.	DESCRIPTION	DATE	APPROVED
-	-	-	-
-	-	-	-

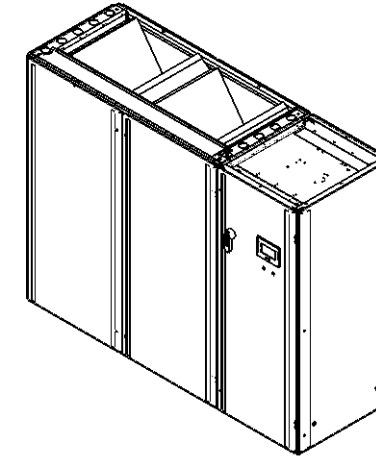
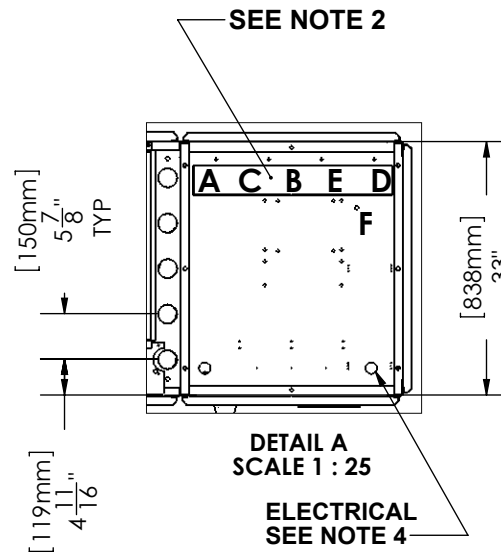
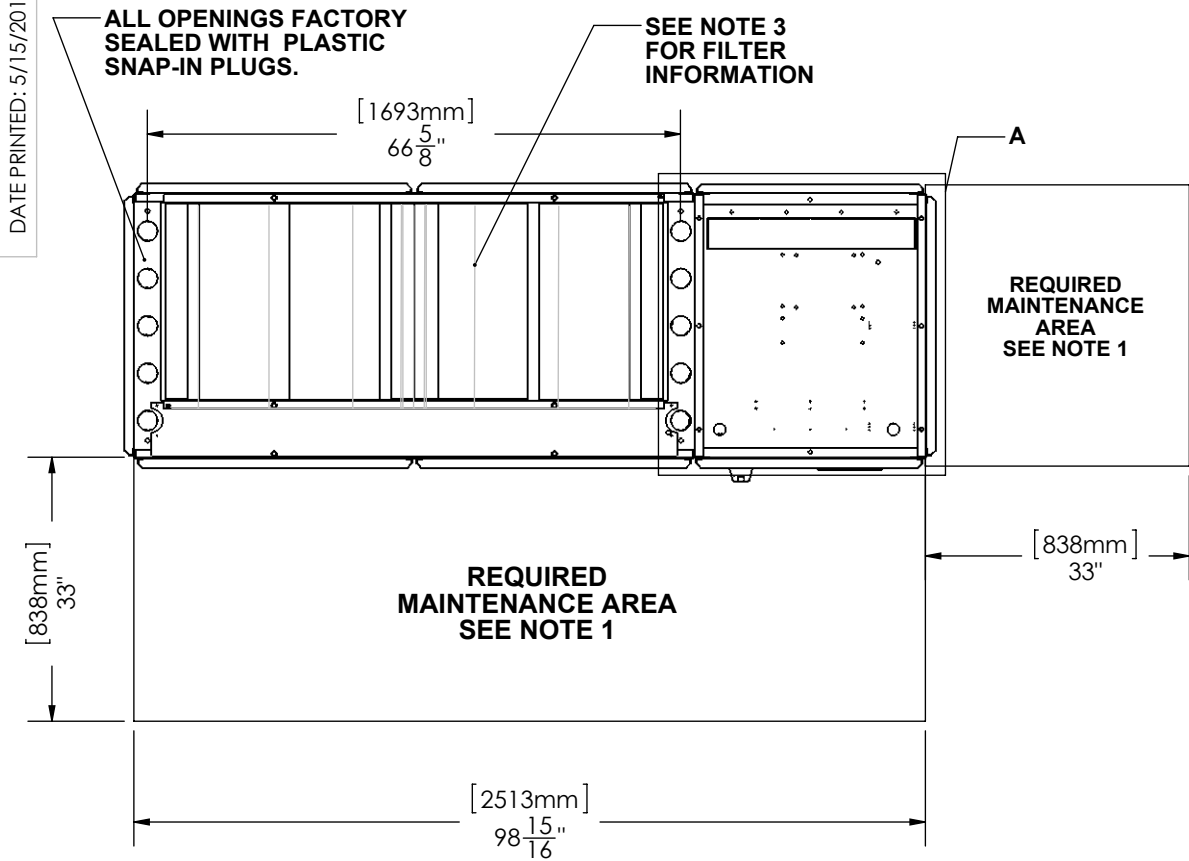

PIPING CONNECTION SIZES

A	HOT WATER REHEAT Ø 7/8" - RETURN
B	HOT WATER REHEAT Ø 7/8" - SUPPLY
C	GLYCOL SUPPLY Ø 2 1/8"
D	CONDENSATE DRAIN Ø 3/4"
E	GLYCOL RETURN Ø 2 1/8"
F	HUMIDIFIER WATER SUPPLY Ø 1/4"

NOTES:

NOTES:

- FANS, MOTORS, VALVES AND ELECTRICAL PANEL ARE FRONT SERVICEABLE.
- ALL PIPING THROUGH BOTTOM PIPING HOLES UNLESS SPECIFIED AT TIME OF ORDER. UNUSED HOLES WILL BE FACTORY PLUGGED.
- IF NO RETURN AIR PLENUM FILTER BOX IS ORDERED, INTERNAL FILTER BOX SET WILL BE SUPPLIED. FILTER SIZE 20"X25", QUANTITY 6. (FILTER SIZE AND QUANTITY FOR INTERNAL FILTER BOX ONLY SEE R/A PLENUM DRAWING FOR OTHER SIZES). SEE MAINTENANCE AREA REQUIRED.
- ELECTRICAL WIRING THROUGH TOP OR BOTTOM HOLES. ALL ENTRY POINTS MUST BE SEALED BY CONTRACTOR.
- FANS AVAILABLE IN BOTH UPPER AND LOWERED POSITION. PLEASE SPECIFY WHEN ORDERED. FANS LOWERED INTO THE FLOOR WILL SHIP IN THE RAISED POSITION. SEE FACTORY LOWERING INSTRUCTIONS.
- AUTO TRANSFER SWITCH INDICATOR LIGHTS OPTIONAL.

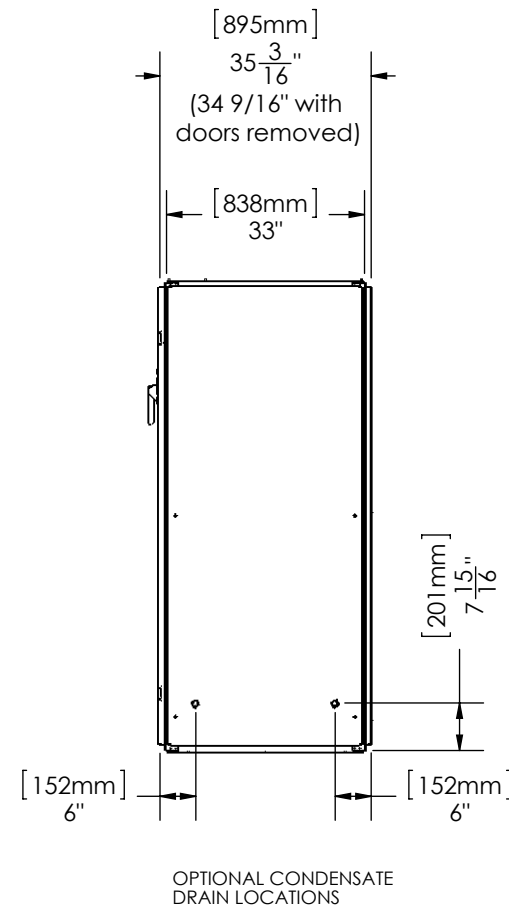
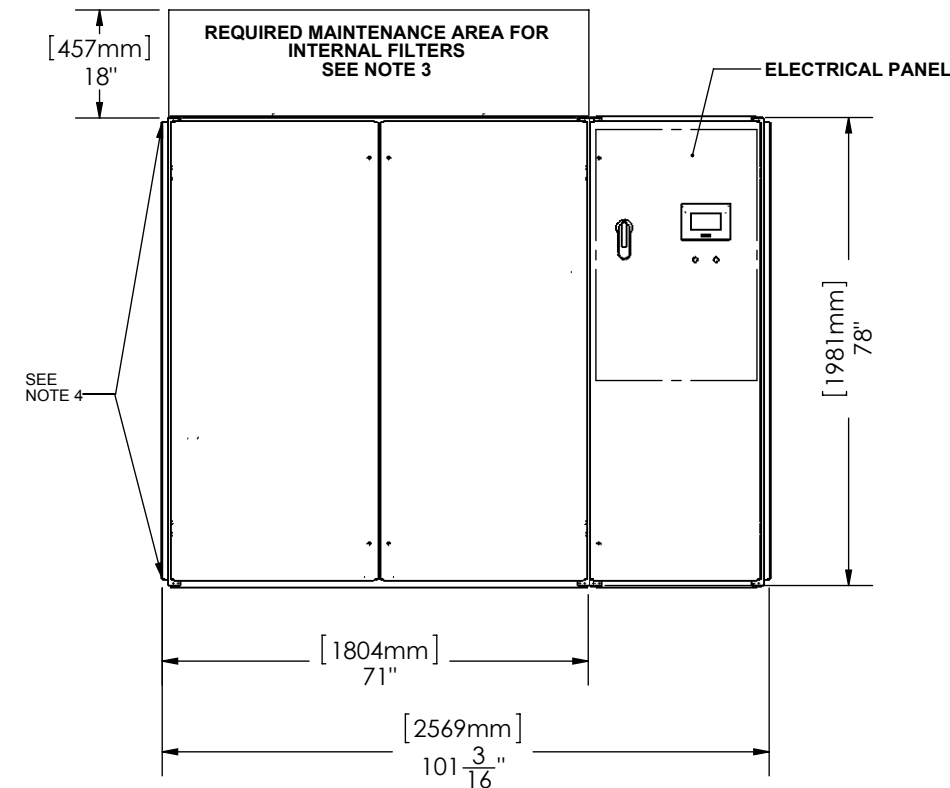

FANS IN RAISED WORKING POSITION (SHIPPING POSITION)

FANS IN SHIPPING POSITION SEE NOTE 5

FANS IN LOWERED WORKING POSITION (OPTIONAL)

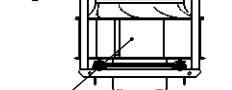
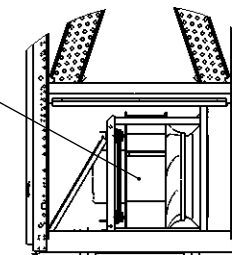
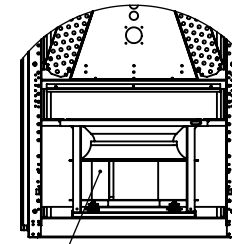

UNLESS OTHERWISE SPECIFIED DIMENSIONS ARE IN INCHES
TOLERANCES:
FRACTIONAL ± 1/8
ANGULAR: ± 0.5° BEND ± 2°
DECIMAL
XXX = ±.010
XX = ±.020
X = ±.030
HOLE DIA. +.003/-000

THIRD ANGLE PROJECTION

	BY	DATE
DRAWN	IZ	11/06/2009
CHECKED	GN	11/06/2009
CNC PROGRAM		
FINISH:	TEXTURED POWDERCOAT	
MATERIAL	N/A	THICKNESS N/A

		FINAL ASSEMBLY	
		DIMENSIONAL DETAIL DOWN FLOW	
		DUAL OR FREE COOLING 57 TO 65 kW	
PART NAME		SPDD-FPB	
SIZE	DWG. NO.	REV. SEE TABLE	
B	SPDD-FPB	BD	N/A
		K	
		SCALE: 1:20	SHEET 1 OF 1

IN FOLDER V:\CANATAL\P-SERIES\P-SERIES FAMILY\SUBMITTAL DRAWINGS\DOWNFLOW\

CONFIDENTIAL: THE COPYRIGHT OF THIS DOCUMENT IS RESERVED BY CLIMATEWORX. THIS DOCUMENT IS ISSUED ON THE CONDITION THAT IT IS NOT COPIED, REPRODUCED OR DISCLOSED TO ANY OTHER PARTY WITHOUT WRITTEN CONSENT OF CLIMATEWORX.